

Mouse Hole Depth = 75 ft

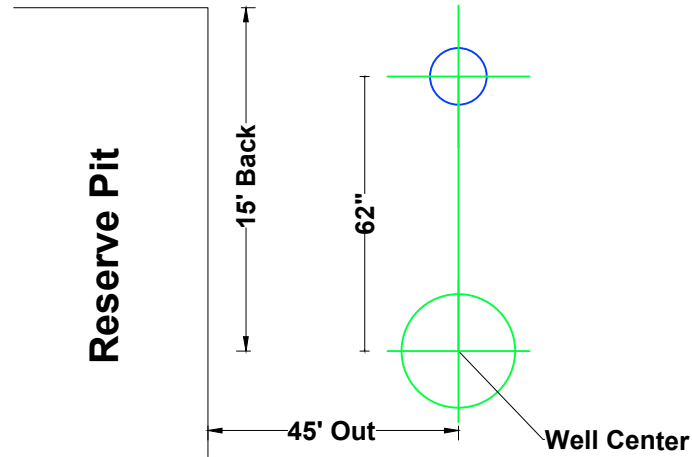

This drawing is owned by and contains proprietary information of Cyclone Drilling, Inc. It is conditionally loaned and it is to be returned upon completion of work or upon earlier request. The borrower by receiving it has agreed not to reproduce nor to copy it in whole or in part nor to furnish information from it to others nor to make any use of it or the information contained therein except for or under specific license from Cyclone Drilling, Inc.

			CUSTOMER	Cyclone Drilling, Inc. Gillette, WY Phone: 307-682-4161 Fax: 307-682-3158
			DWG BY N.T. L	
			NOTE: ALL DIMENSIONS ARE FROM THE CENTER OF THE MH-RH TO WELL CENTER.	
			DRAWN ON: 11-7-2011	TITLE: RIG 5 MH-RH DIAGRAM
			DIMENSIONS IN INCHES	
DATE :	REVISION	BY:	SCALE: N/A	AutoCAD DWG